

Model: HD06R



Electric Parameters

- Working Voltage: AAA battery * 2pcs (2.2-3V)
- Screen OFF Duration: 60S
- Icon Flicking Duration: 5S
- S(start) button ON Duration: 10S
- M(Memory) button Flicking Duration: 3S
- Carrier Frequency: 38KHz±2KHz
- Operation Distance Max. 15M/49ft (3V)
- Emission Angle: < 30 degree
- Standby Current: < 1.2uA
- Working Current: < 5mA
- Peak Current: < 30mA
- Working Temp: -20°C~+60°C
- Storage Temp: -30°C~+85°C

Demensions

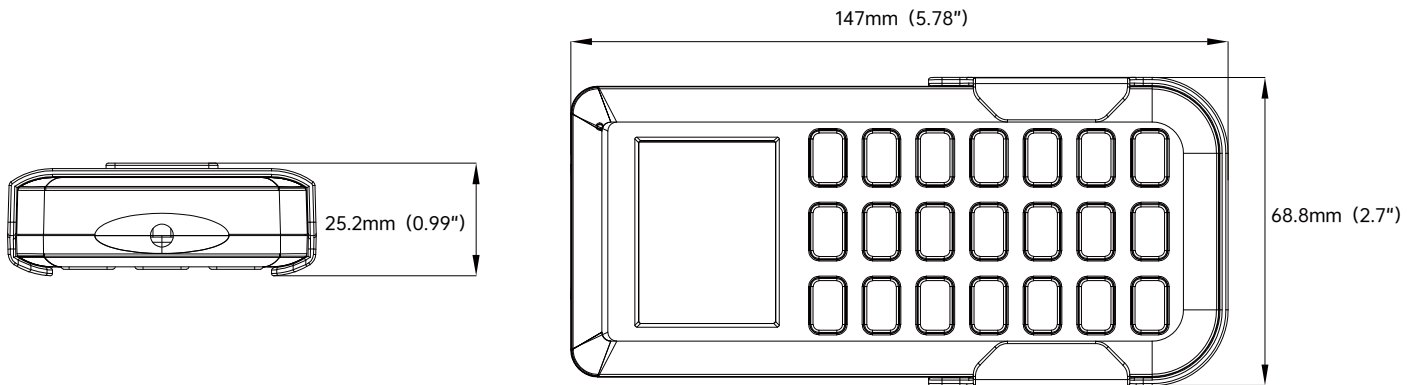



















User LCD Screen Display

	Detection Area
	Holdtime
	Standy Dim Level
	Standby Period
	Daylight Threshold
	Brightness

	CCT Selected
AM	AM means "Auto Mode", AM not showing means "manually control mode"
DH_{OFF}	Daylight Harvesting enabled or disabled
S M	"Start" or "Memory" scene parameters
SK-02	Reserved area for the future
HP	Mounting Height

Briefing of Button Functions

Buttons	Function	Function Performance
	ON/OFF	Turn ON or OFF light and keep the sensor in ON/OFF mode.
	Auto	Enter into SENSOR MODE and perform the last time setting.
	Reset	Go back to default program; Enter into SENSOR MODE and perform the default program.
Function Programming Buttons ▼		
	Scenes	Keep favorable program(Detection area, holdtime, daylight threshold, standby dim level and standby period) into different scenes and apply them quickly.
	Start	Press this button to start programming, S icon on LCD screen display started to blink; after programming press MEMORY button, S icon keeps being.
	Memory	Press this button to memorize program and saved it into SCENES; after pressing it, M icon's bright then off after 3S.
	Apply	Press this button to send the program(detection area, holdtime, daylight threshold, standby dim level and standby period) and sensor works in SENSOR mode.
	Mounting Height	Adjust detection area/sensitivity levels according to real installation situations, higher or lower.
	Send	Memorize and send out the last time setting of individual parameters(detection area, holdtime, standby dim level, standby period, daylight threshold, power, CCT, Daylight Harvesting, ON/OFF, Auto, Reset, Mounting Height, test)
	Detection Area	Adjust from detection area options 25%, 50%, 75% and 100%.
	Daylight Threshold	Adjust from daylight threshold options, there are "---"(disable), 2lux, 10lux, 30lux, 50lux, 80lux, 120lux, 200lux, 250lux, 300lux, 350lux, 400lux, LEN(daylight learning).
	Standby Dim Level	Adjust from standby dim levels, 10%, 20%, 30% and 50%.
	Holdtime	Adjust from holdtime options: 5S, 30S, 1min, 3min, 5min, 10min, 20min and 30min.
	Standby Period	Adjust from Standby Period options, 0S, 10S, 30S, 1min, 5min, 10min, 30min, 60min and "--" as infinite.
	CCT Selectable	(To work with CCT supported sensors)Adjust from CCT options, 2700K, 3500K, 4000K, 5000K, 5700K, 6500K.
	Brightness Adjustable	Adjust brightness in both ON/OFF mode & SENSOR mode, minimum 10%, max 100%, each pressing makes 5% change.
	Reserved Button	This remote control works for the next years, we keep this reserved button for the future reference.
	Daylight Harvesting	Daylight harvesting function enabled or disabled.
	Test Button	Quick testing button for only 2S ON then OFF.
	+	Choose higher parameters. Tips: 1. Press POWER button then keep pressing + button get you directly to 100%
	-	Choose lower parameters. Tips: 1. Press POWER button then keep pressing - button get you directly to 10%